

ROLLER-BLINDS CATALOGUES

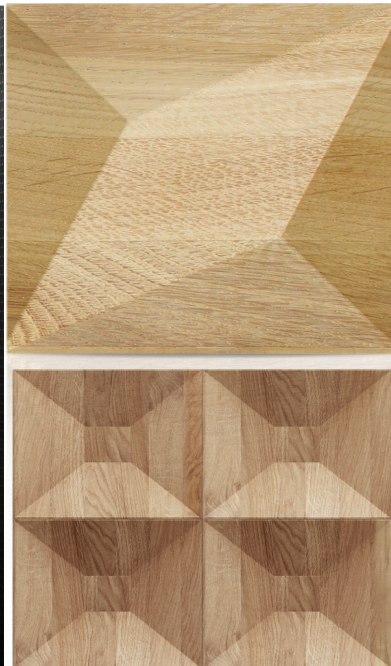

acoustic4you
acoustic solutions



Furniture roller-blinds

Furniture roller-blinds – veneer, laminate stainless steel, aluminum, solid wood

Realization of RD covering, RA aluminum laminate and RN stainless steel



- Slat width 10, 15 and 20 mm
- Thickness 6 mm
- laminated wooden core which provides stability of boards
- Cloth supporting material of high durability
- Finely grounded RD for further surface processing
- RA, RN with protection against scratching

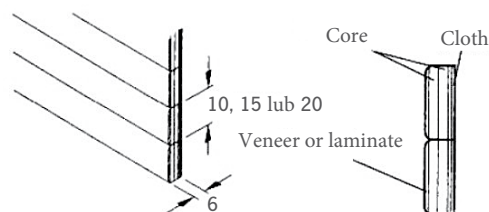

Sizes of roller-blinds

Width (Slat length) 600, 900 and 1200 mm

- Length 1200 and 2400 mm

maximum

- Width (Slat length) 1800 mm Length 2800 mm
- For non-standard sizes additional fee is required in the amount of + 15%

We manufacture on request roller-blinds out of solid RM wood, adequate for furniture renovation, wall or pillar covering.

board width 15 mm

- Thickness 6 mm
- High durability material for cloth enhancement
- Finely ground RM for further surface processing



RM15



RD xx

RA xx

RN xx

(xx = Slots width)

We offer veneer coverings of almost any type available on the market!
We arrange price on basis of your request. Delivery time: 2 -3 weeks

Furniture roller-blinds - accessories

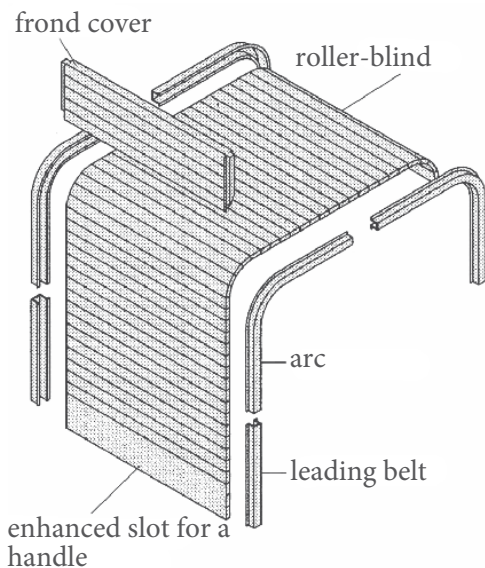

RNKSL222

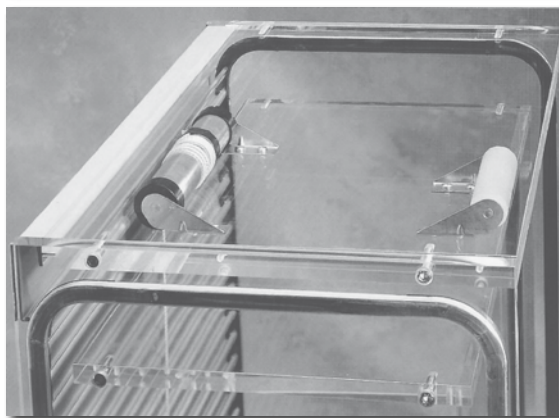

Balancing fitting RNKSL222

- For cabinets, using depth
- Direct, easy installation

ROL60

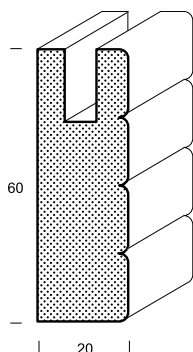

OD2020

Support

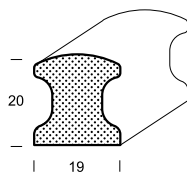

RNC ROL75

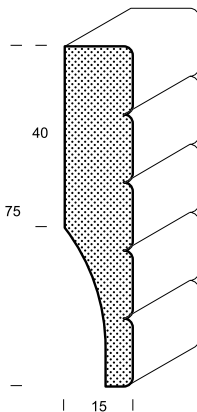

RNK

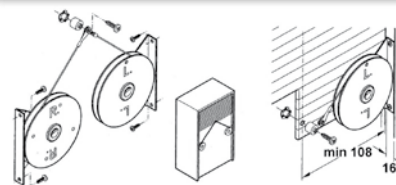

RNK Balancing fitting

- For cabinets with required height
- Installed from back, easily.

Enhanced blade for 50 mm handle

- RNC dla RD, RA, RN
- RNC w wersji

Standard order:

Roller width = cabinet width
light + 11 mm roller-blind length

- during RNK installation = cabinet height + cabinet depth
- during RNKSL222 installation = cabinet height + 100 mm
- with no connectors = cabinet height + 100 mm

Front cover

- RNC for RD, RA, RN
- RNC in smooth or grooved version
- ROL75 for RM



Leading profiles for routing

- Leading rail VL95 (rail length 250 cm)
- Leading corner RVL95
- PCV finishing in brown, black and grey color
- groove 11 mm

PRICELIST in POLISH ZLOTY

	j.m	Spruce	Oak	Beech	Ash	Sycamore	Birch	Wild cherry	Alder	Walnut	Rosewood	Steel,aluminum
RD10	m ²	750,-	750,-	750,-	750,-	760,-	750,-	800,-	750,-	870,-	870,-	-
RD15 (20)	m ²	650,-	650,-	650,-	650,-	630,-	650,-	670,-	650,-	720,-	720,-	-
RM15	m ²	-	710,-	700,-	-	-	-	-	-	-	-	-
RA RN 15(20)	m ²	-	-	-	-	-	-	-	-	-	-	980,-
RNK	szt	-	-	-	-	-	30,-	-	-	-	-	-
RNKSL222	szt	-	-	-	-	-	180,-	-	-	-	-	-
VL95	szt	-	-	-	-	-	25,-	-	-	-	-	-
RVL95	szt	-	-	-	-	-	27,-	-	-	-	-	-
ROL60	mb	40,-	50,-	50,-	-	-	40,-	-	40,-	-	-	-
RNC	mb	90,-	90,-	90,-	90,-	90,-	95,-	100,-	-	95,-	140,-	120,-
ROL75	mb	40,-	80,-	50,-	-	-	50,-	-	50,-	-	-	-
OD2020	mb	25,-	25,-	25,-	-	-	25,-	-	25,-	-	-	-