

③ TOCKKY FWP - FELT WRAPPED PANEL
1'x4' - ELEVATION
1 1/2" = 1'-0"

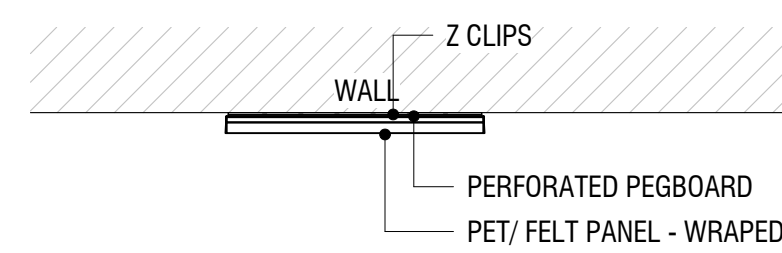

① TOCKKY FWP - FELT WRAPPED PANEL
1'x4' - PLAN VIEW
1 1/2" = 1'-0"

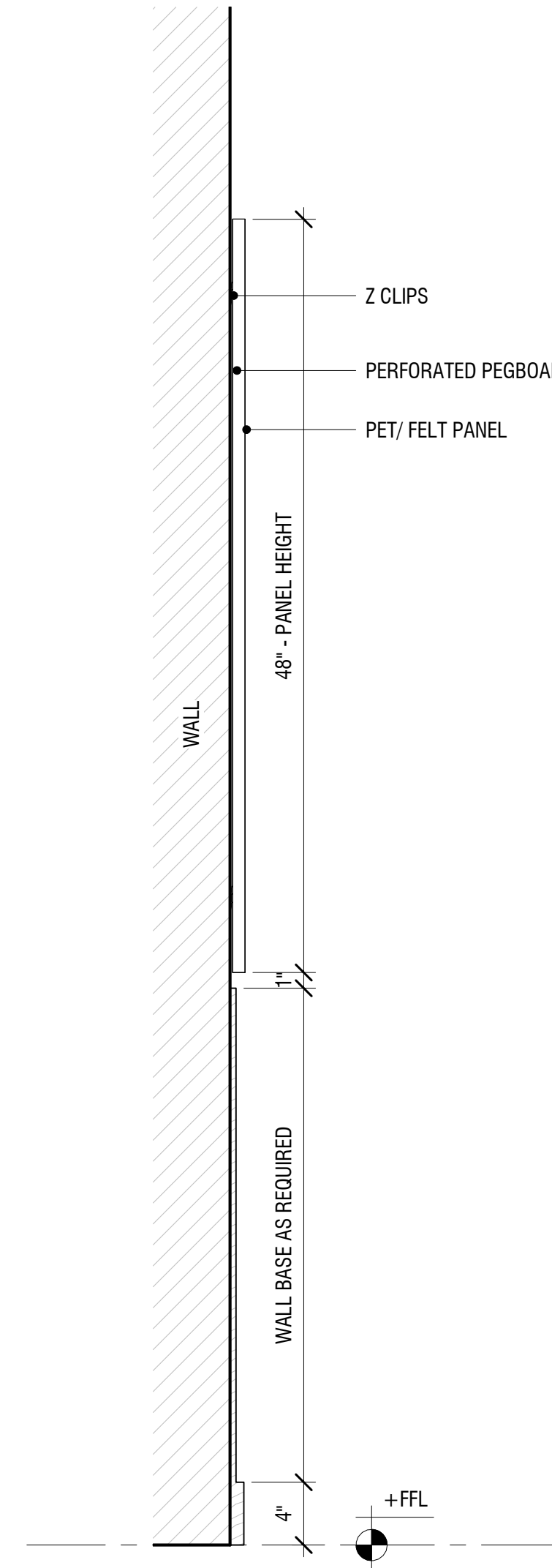

④ TOCKKY FWP - FELT WRAPPED PANEL
1'x4' - TYP. SECTION
1 1/2" = 1'-0"

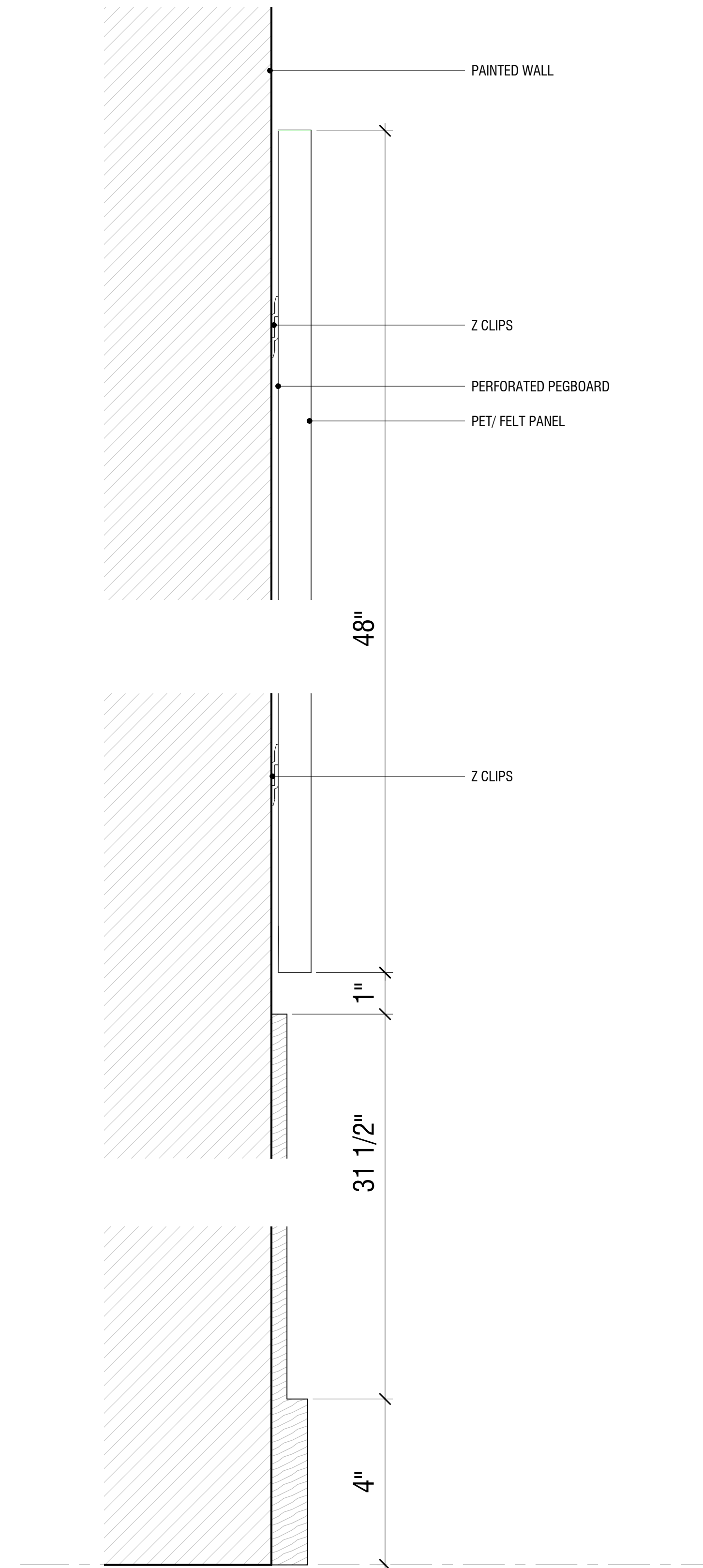

② TOCKKY FWP - FELT WRAPPED PANEL
1'x4' - SECTIONAL DETAIL
6" = 1'-0"

NO.	REVISIONS:	NAME:	DATE:
1	SUBMISSION FOR APPROVAL		
2			
3			
4			



Product 6 - Tockky FWP
Felt Wrapped Panels

DATE:
DRAWN BY:
DRAWING TITLE: TOCKKY FWP - FELT WRAPPED PANEL 1'x4'
PROJECT NUMBER:
DRAWING NUMBER: 1.0

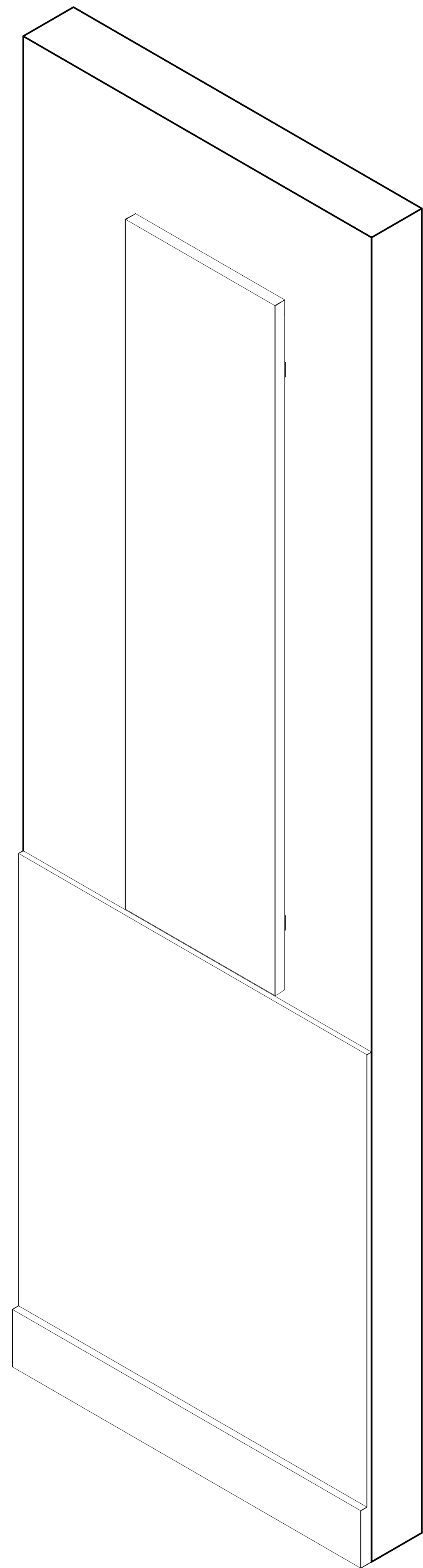

1 TOCKKY FWP - FELT WRAPPED PANEL
1x4' - AXONOMETRIC FRONT VIEW

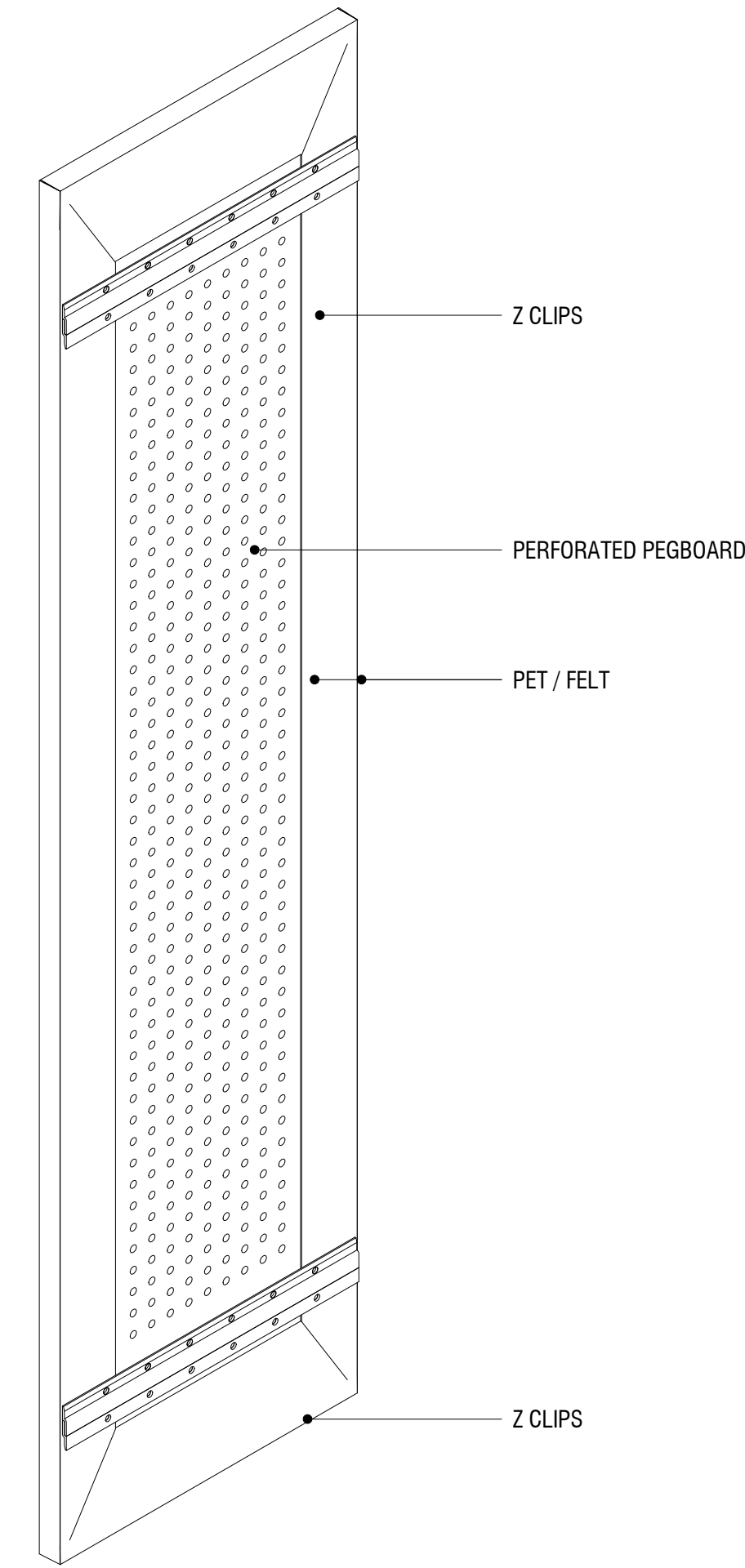

2 TOCKKY FWP - FELT WRAPPED PANEL
1x4' - AXONOMETRIC REAR VIEW

DATE:

NAME:

REVISIONS:
SUBMISSION FOR APPROVAL

NO:

1

2

3

4



Product 6 - Tockky FWP
Felt Wrapped Panels

DATE:

DRAWN BY:

DRAWING TITLE:

TOCKKY FWP - FELT WRAPPED
PANEL 1x4' - AXONOMETRIC
VIEW

PROJECT NUMBER:

DRAWING NUMBER:

1.1

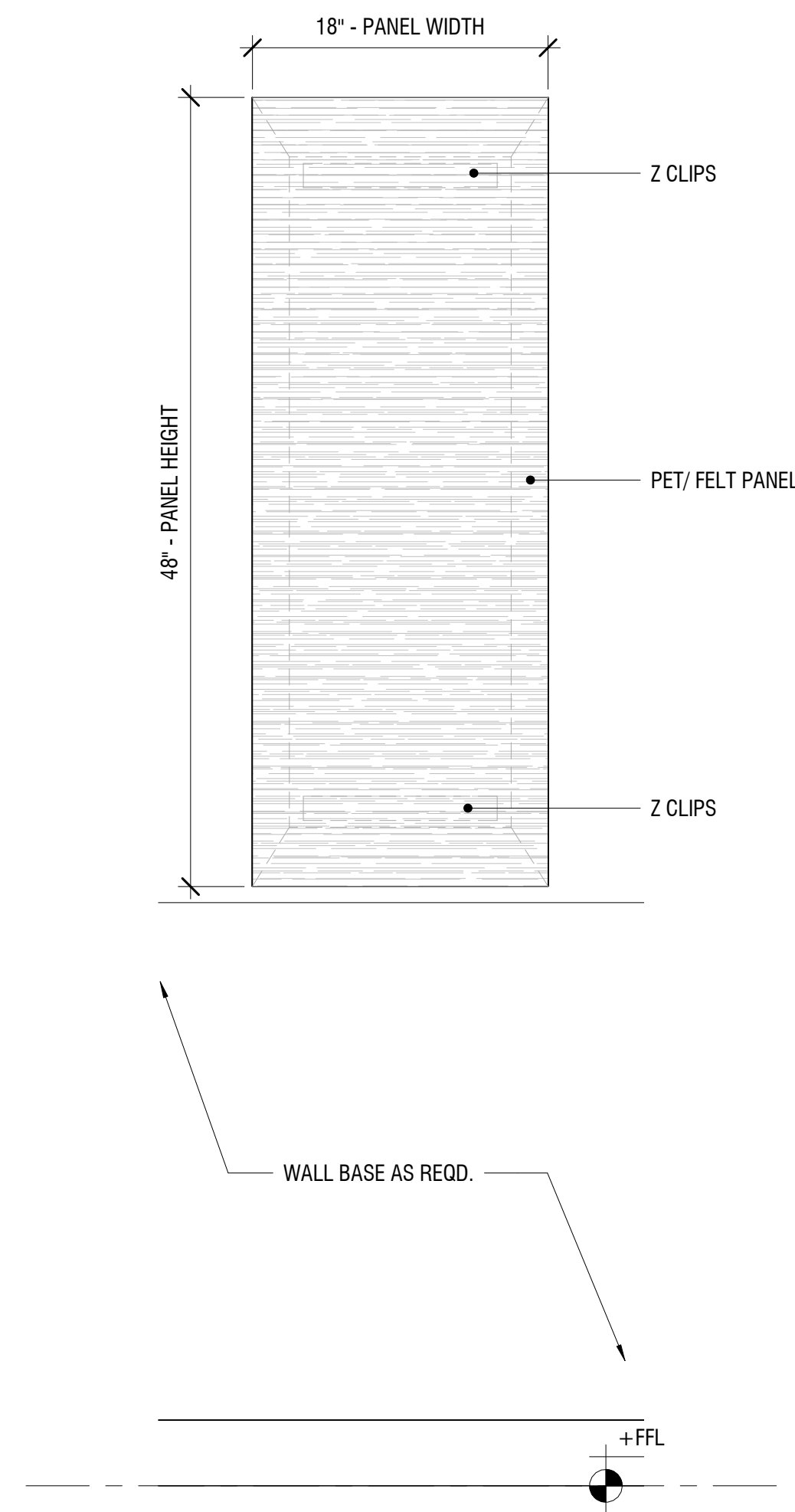

② TOCKKY FWP - FELT WRAPPED PANEL
1 1/2'x4' - ELEVATION
1 1/2" = 1'-0"

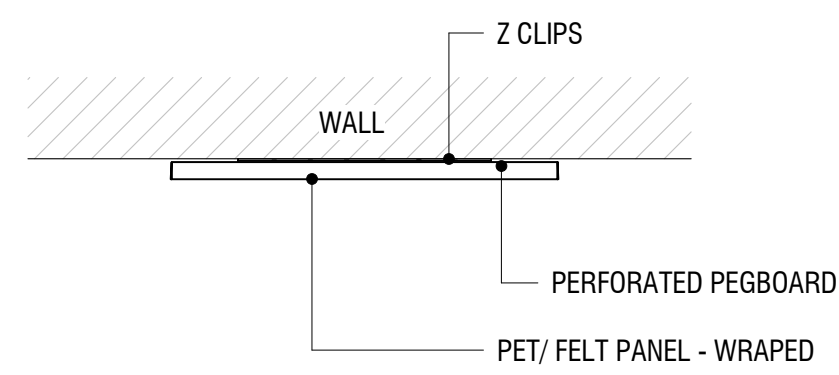

① TOCKKY FWP - FELT WRAPPED PANEL
1 1/2'x4' - PLAN VIEW
1 1/2" = 1'-0"

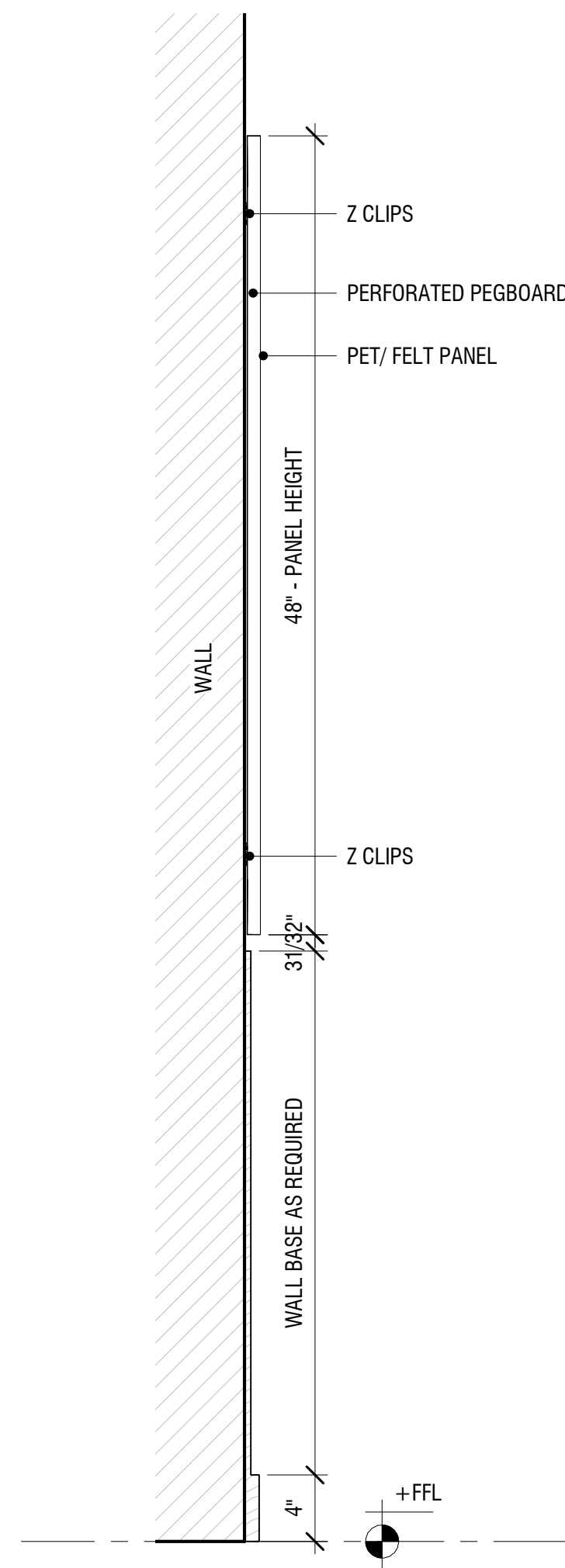

③ TOCKKY FWP - FELT WRAPPED PANEL
1 1/2'x4' - TYP. SECTION
1 1/2" = 1'-0"

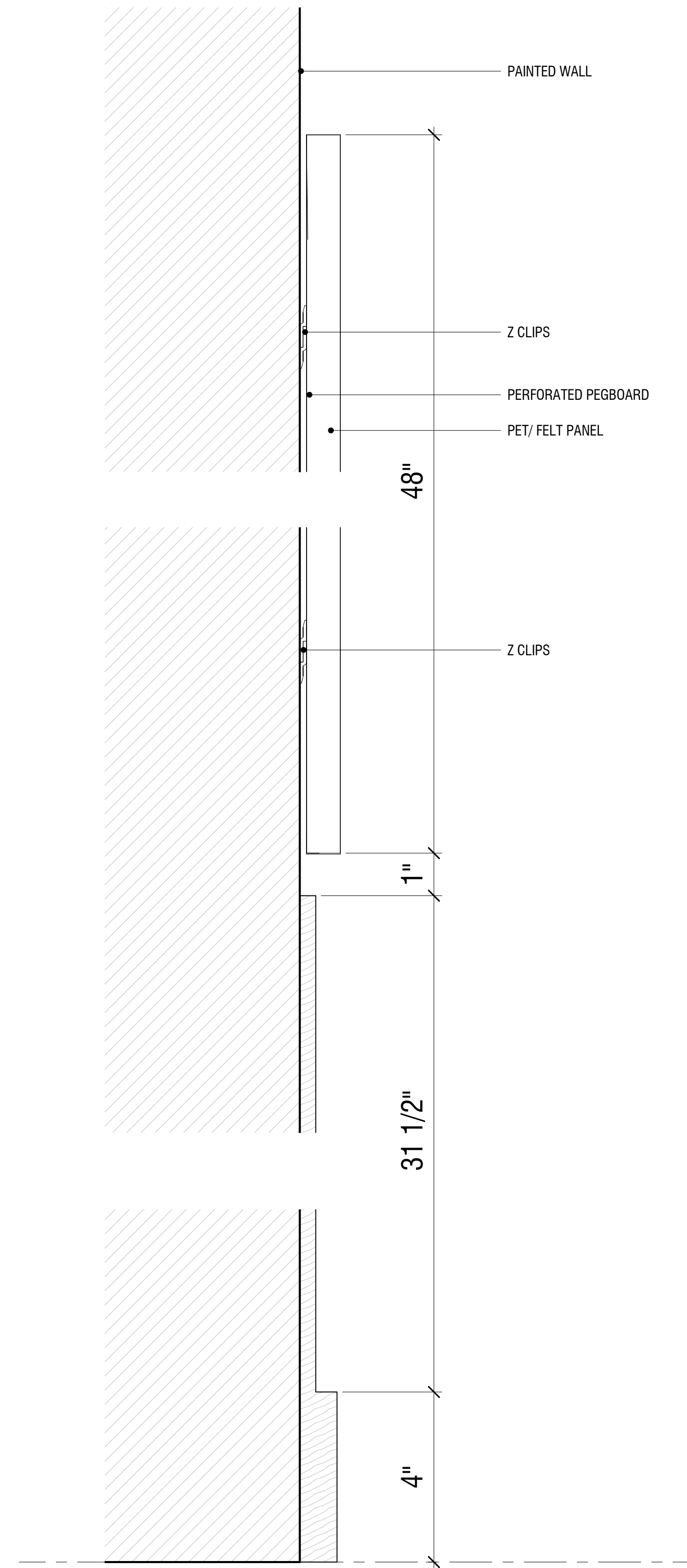

④ TOCKKY FWP - FELT WRAPPED PANEL
1 1/2'x4' - SECTIONAL DETAIL
6" = 1'-0"

NO.	REVISIONS:	DATE:
1	SUBMISSION FOR APPROVAL	
2		
3		
4		



Product 6 - Tockky FWP
Felt Wrapped Panels

DATE:
DRAWN BY:
DRAWING TITLE: TOCKKY FWP - FELT WRAPPED PANEL 1 1/2'x4'
PROJECT NUMBER:
DRAWING NUMBER:

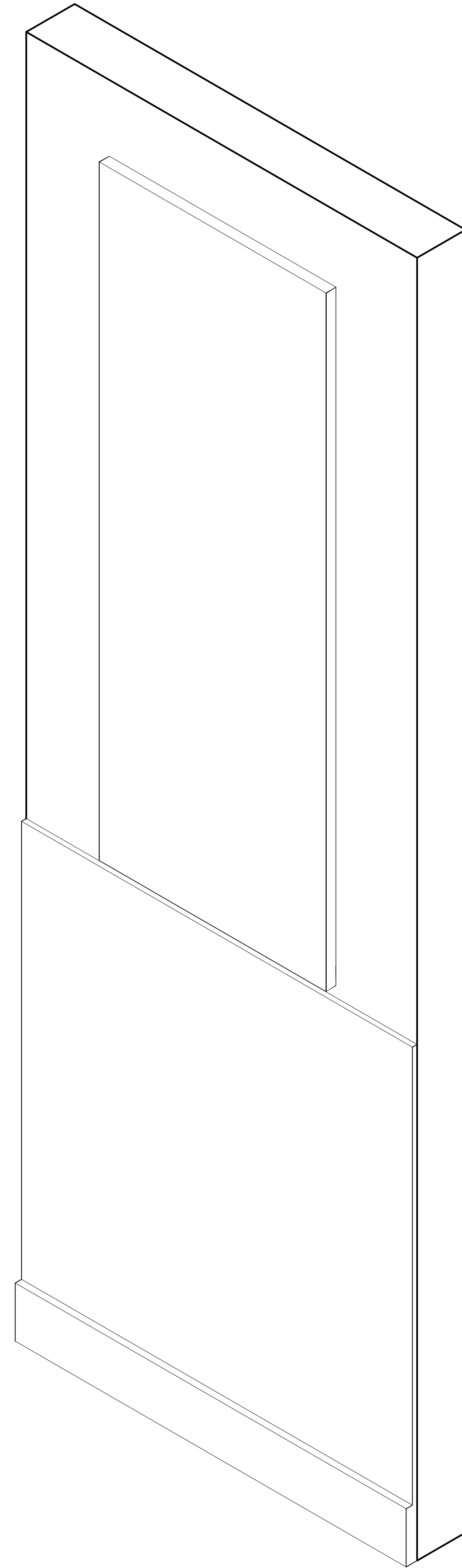

1 TOCKKY FWP - FELT WRAPPED PANEL
1 1/2'x4' - AXONOMETRIC FRONT VIEW

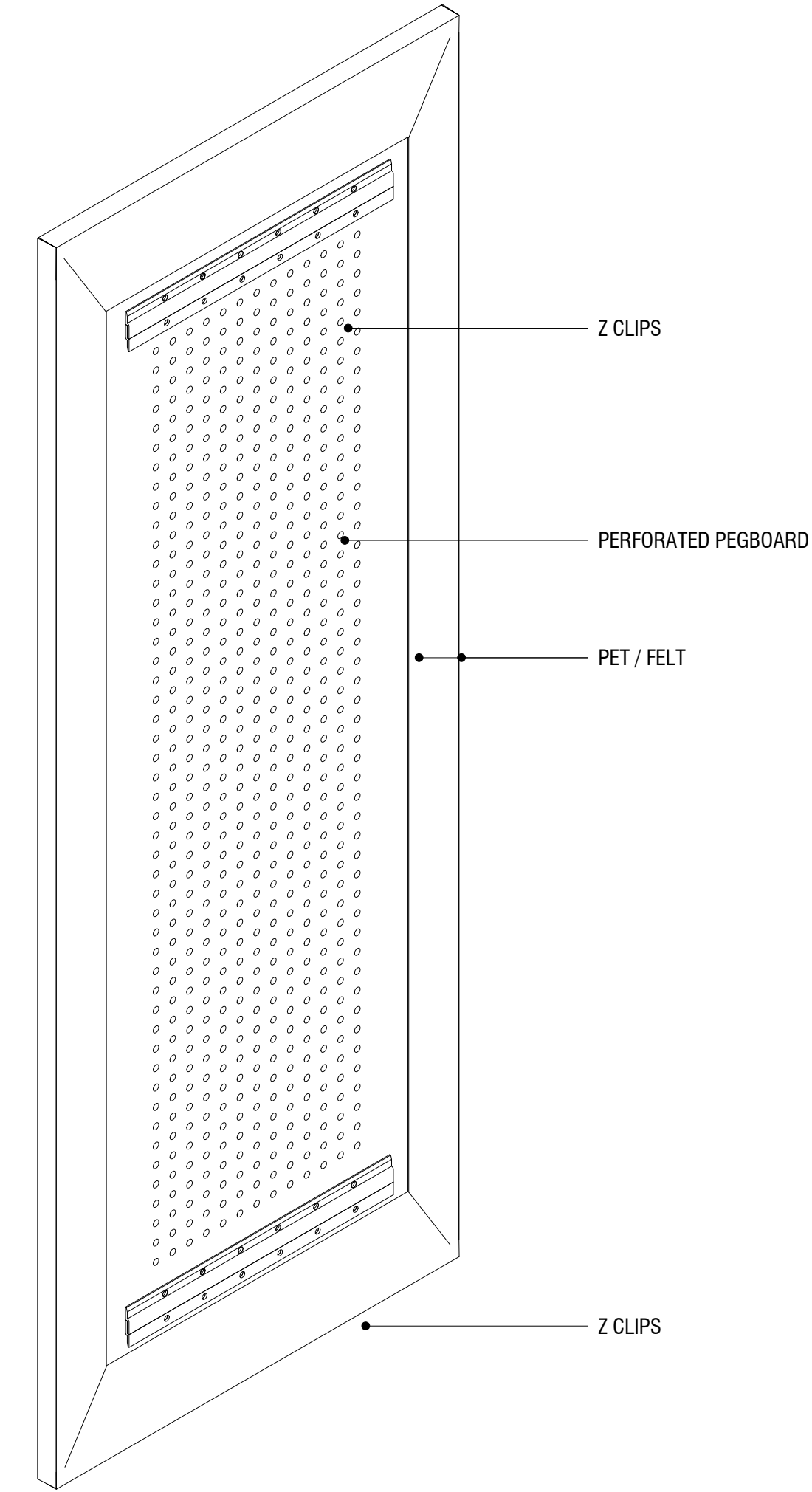

2 TOCKKY FWP - FELT WRAPPED PANEL
1 1/2'x4' - AXONOMETRIC REAR VIEW

NO:	REVISIONS:	NAME:	DATE:
1	SUBMISSION FOR APPROVAL		
2			
3			
4			



Product 6 - Tockky FWP
Felt Wrapped Panels

DATE:
DRAWN BY:
DRAWING TITLE: TOCKKY FWP - FELT WRAPPED PANEL 1 1/2'x4' - AXONOMETRIC VIEW
PROJECT NUMBER:
DRAWING NUMBER: 2.1

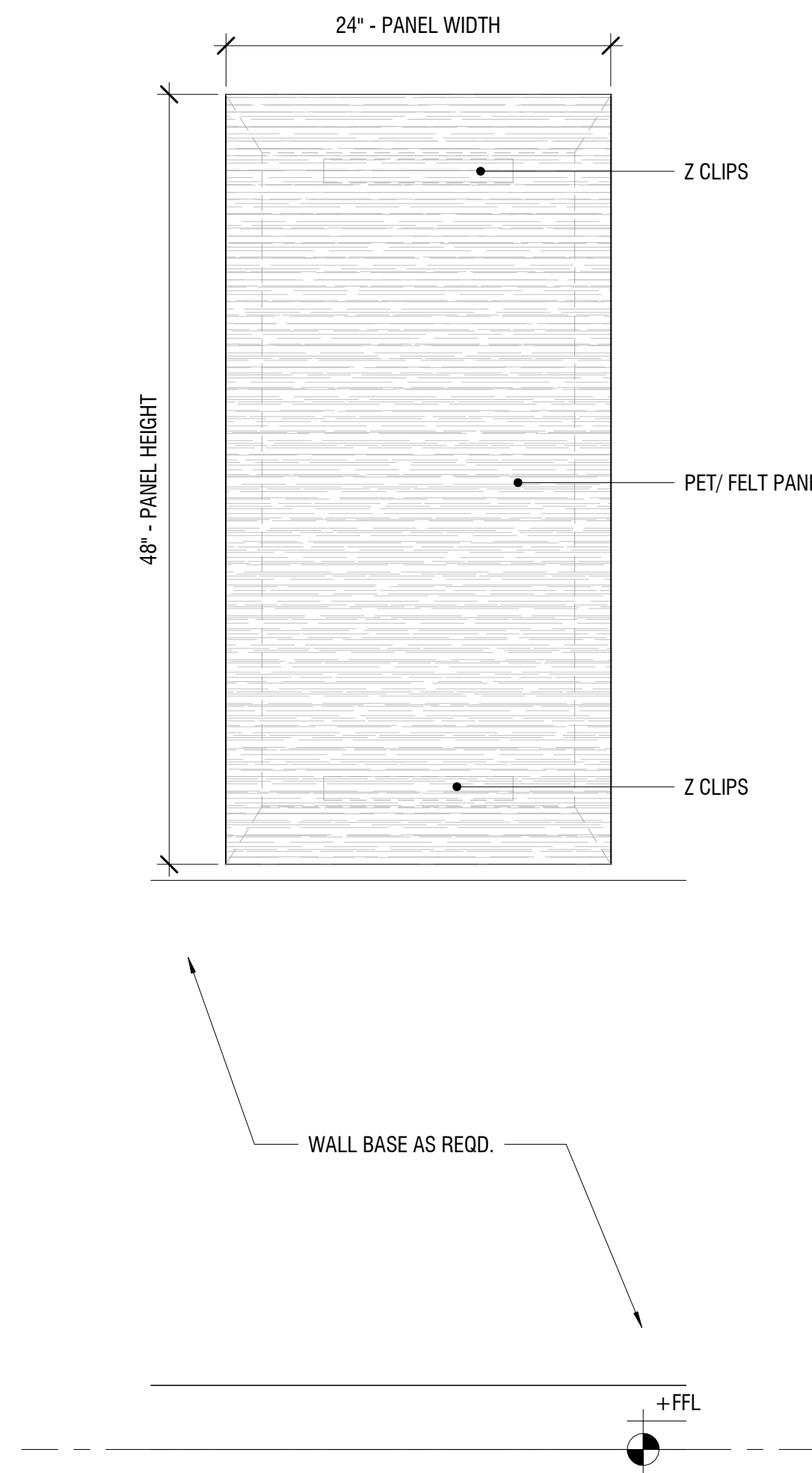

1 TOCKKY FWP - FELT WRAPPED PANEL
2x4' - ELEVATION
1 1/2" = 1'-0"

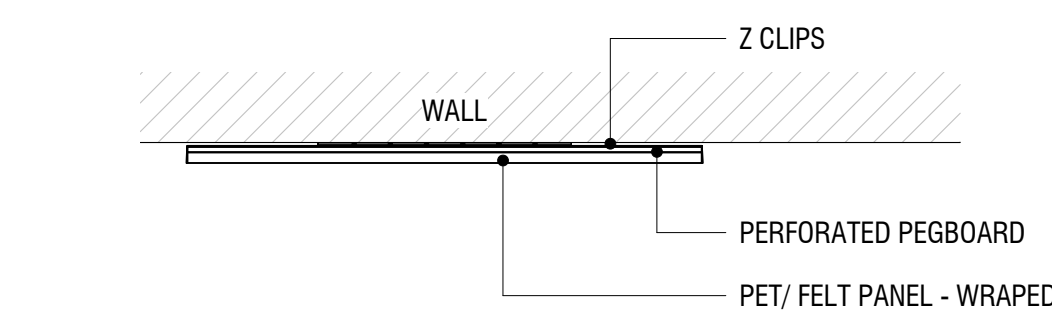

2 TOCKKY FWP - FELT WRAPPED PANEL
2x4' - PLAN VIEW
1 1/2" = 1'-0"

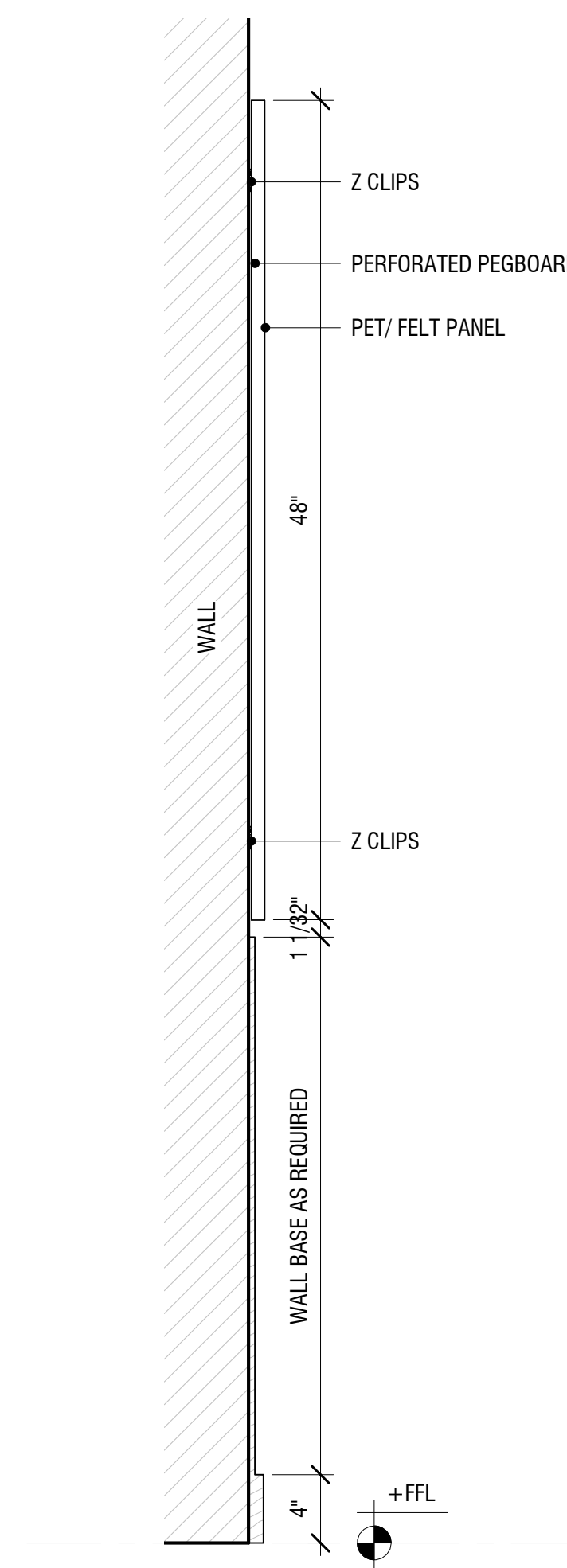

3 TOCKKY FWP - FELT WRAPPED PANEL
2x4' - TYP. SECTION
1 1/2" = 1'-0"

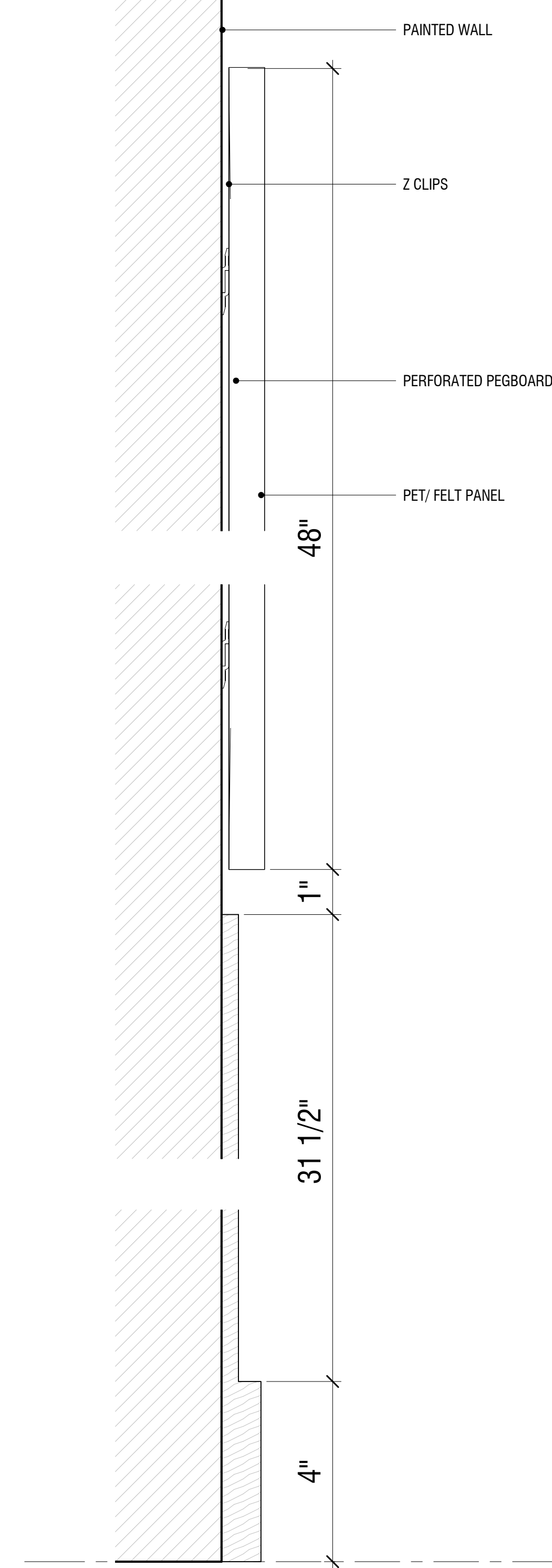

4 TOCKKY FWP - FELT WRAPPED PANEL
2x4' - SECTIONAL DETAIL
6" = 1'-0"

Product 6 - Tockky FWP
Felt Wrapped Panels



NO.	REVISIONS:	NAME:	DATE:
1	SUBMISSION FOR APPROVAL		
2			
3			
4			

DATE:
DRAWN BY:
DRAWING TITLE:
TOCKKY FWP - FELT WRAPPED
PANEL 2'x4'
PROJECT NUMBER:
DRAWING NUMBER:

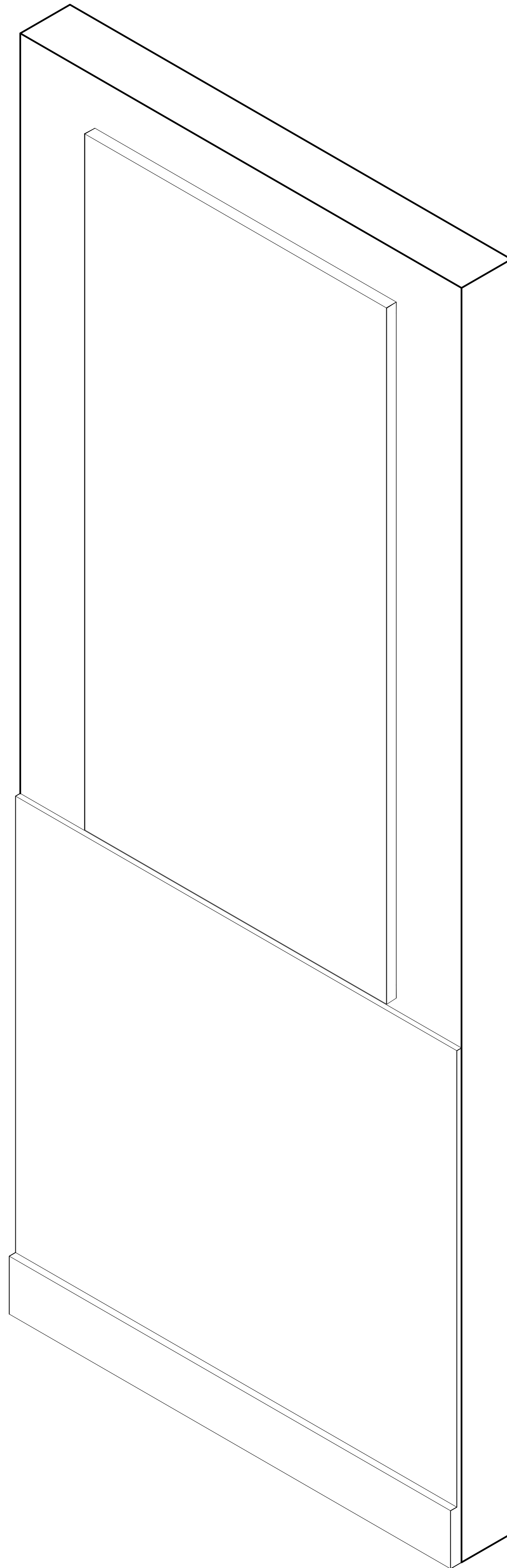

1 TOCKKY FWP - FELT WRAPPED PANEL
2x4' - AXONOMETRIC FRONT VIEW

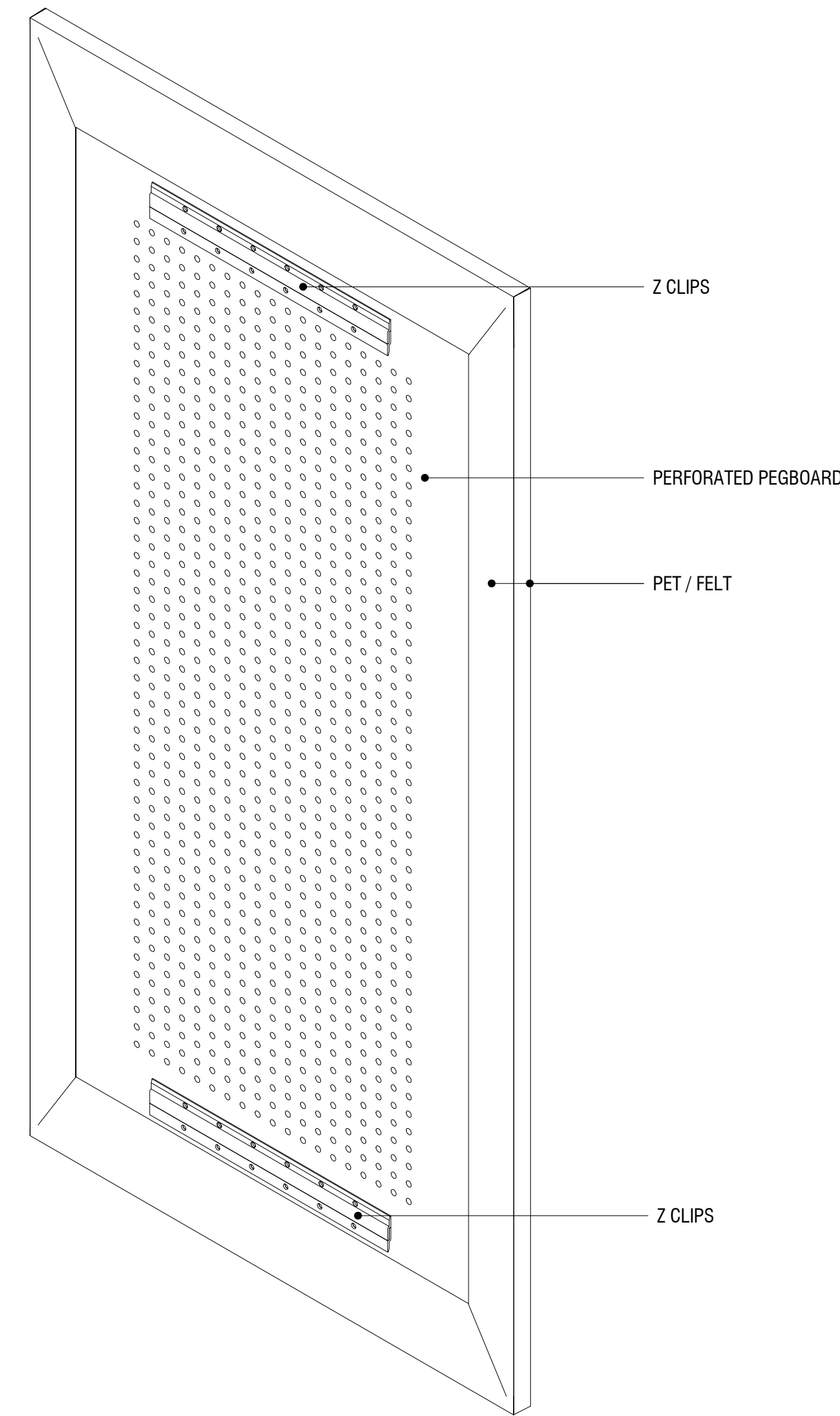

2 TOCKKY FWP - FELT WRAPPED PANEL
2x4' - AXONOMETRIC REAR VIEW

NO:	REVISIONS:	NAME:	DATE:
1	SUBMISSION FOR APPROVAL		
2			
3			
4			



Product 6 - Tockky FWP
Felt Wrapped Panels

DATE:
DRAWN BY:
DRAWING TITLE: TOCKKY FWP - FELT WRAPPED PANEL 2x4' - AXONOMETRIC VIEW
PROJECT NUMBER:
DRAWING NUMBER:

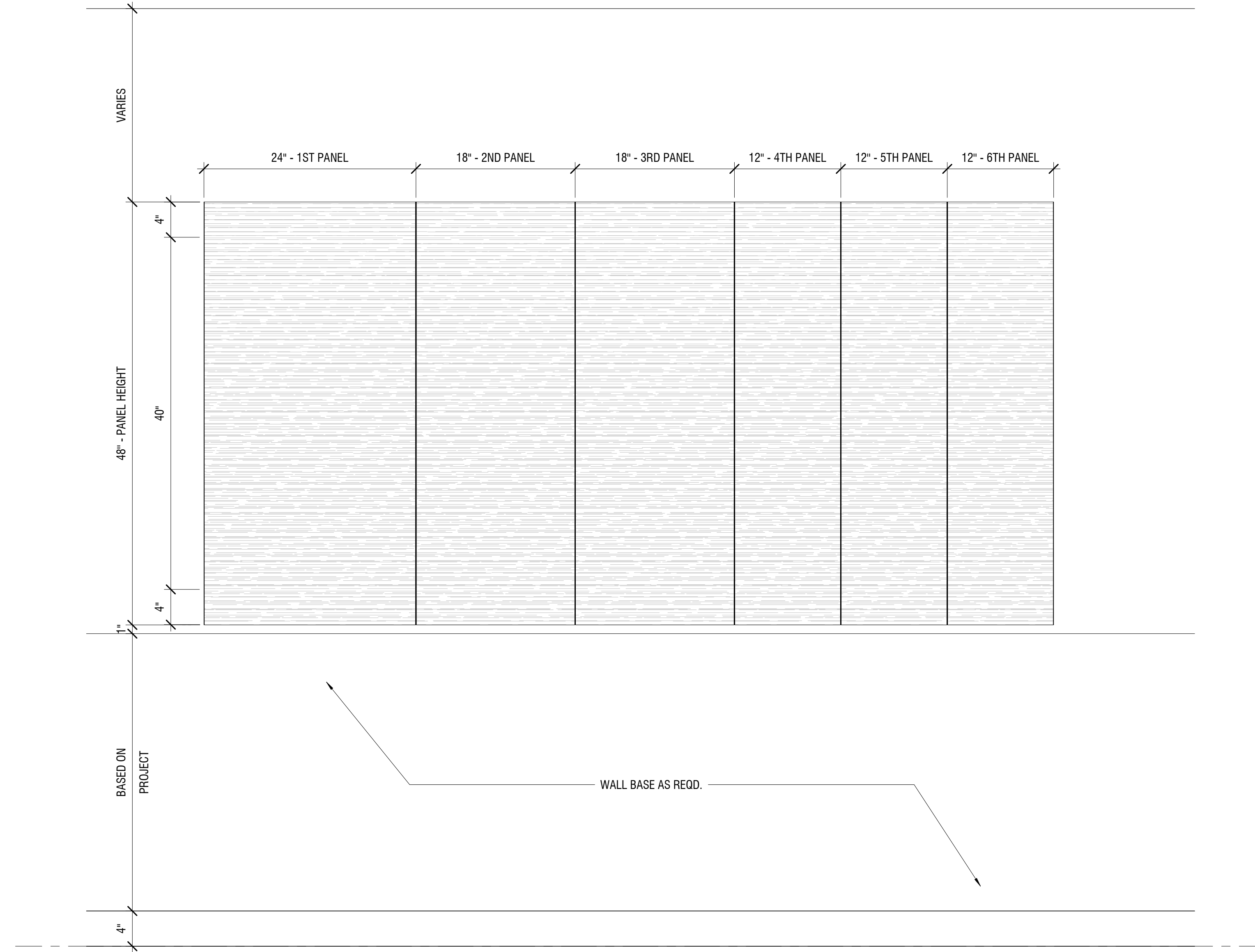

① TOCKKY FWP - FELT WRAPPED PANELS
ASSEMBLY 8'x4' - ELEVATION
1 1/2" = 1'-0"

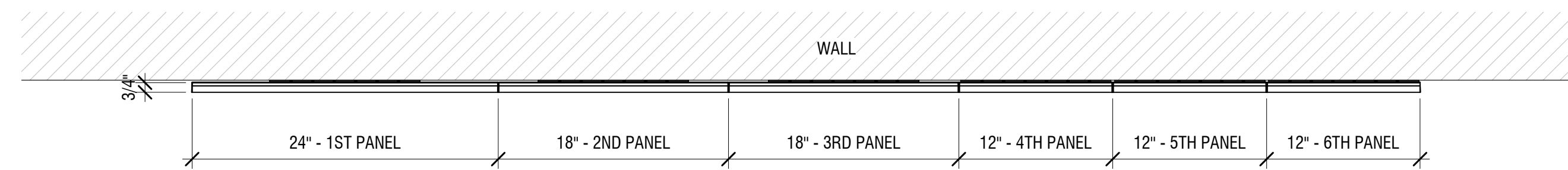

② TOCKKY FWP - FELT WRAPPED PANELS
ASSEMBLY 8'x4' - PLAN VIEW
1 1/2" = 1'-0"

NO.	REVISIONS:	DATE:
1	SUBMISSION FOR APPROVAL	
2		
3		
4		



Product 6 - Tockky FWP
Felt Wrapped Panels

DATE:
DRAWN BY:
DRAWING TITLE: TOCKKY FWP - FELT WRAPPED PANELS ASSEMBLY 8'x4'
PROJECT NUMBER:
DRAWING NUMBER:

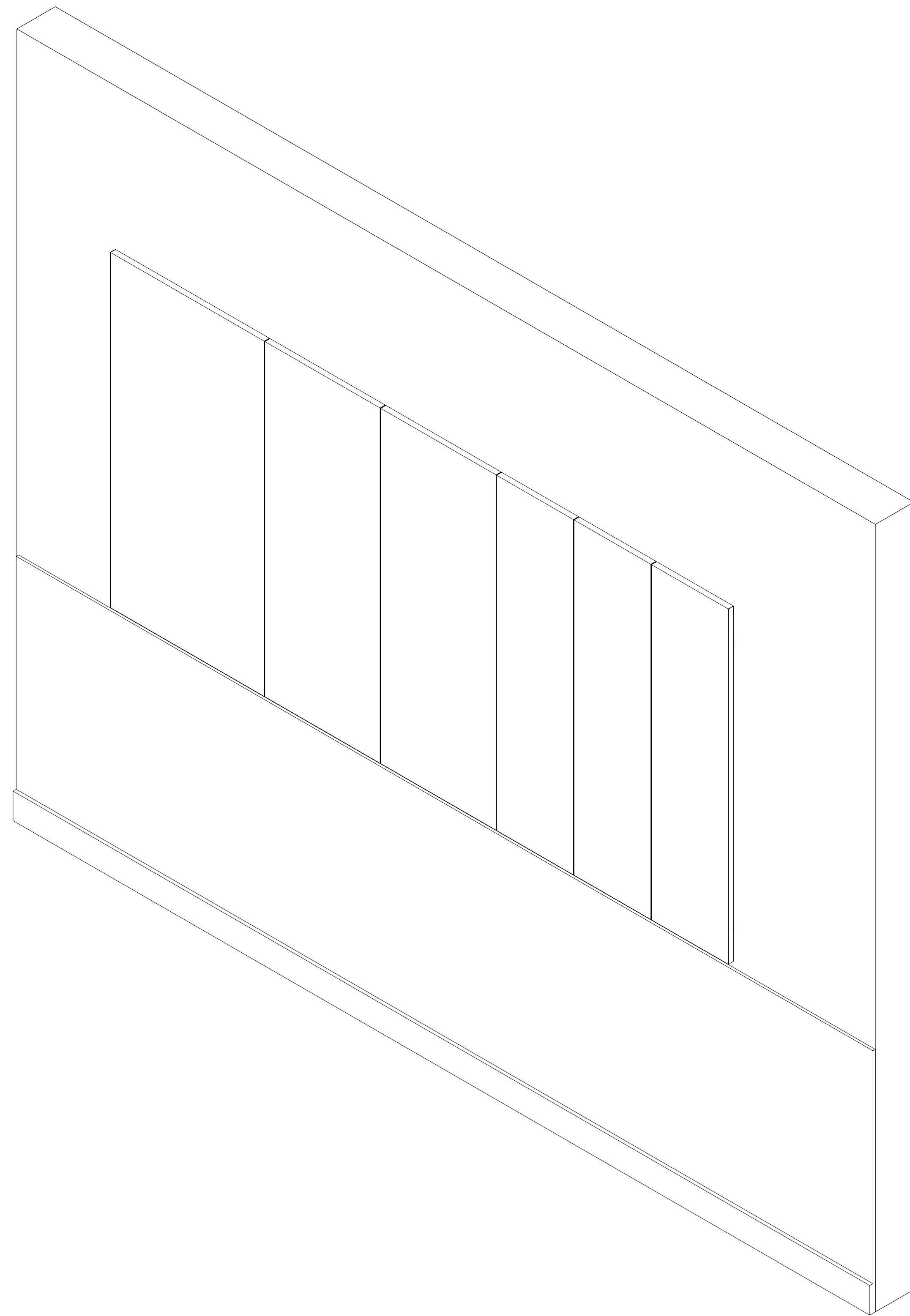

1 TOCKKY FWP - FELT WRAPPED PANELS
ASSEMBLY 8'x4' - AXONOMETRIC VIEW

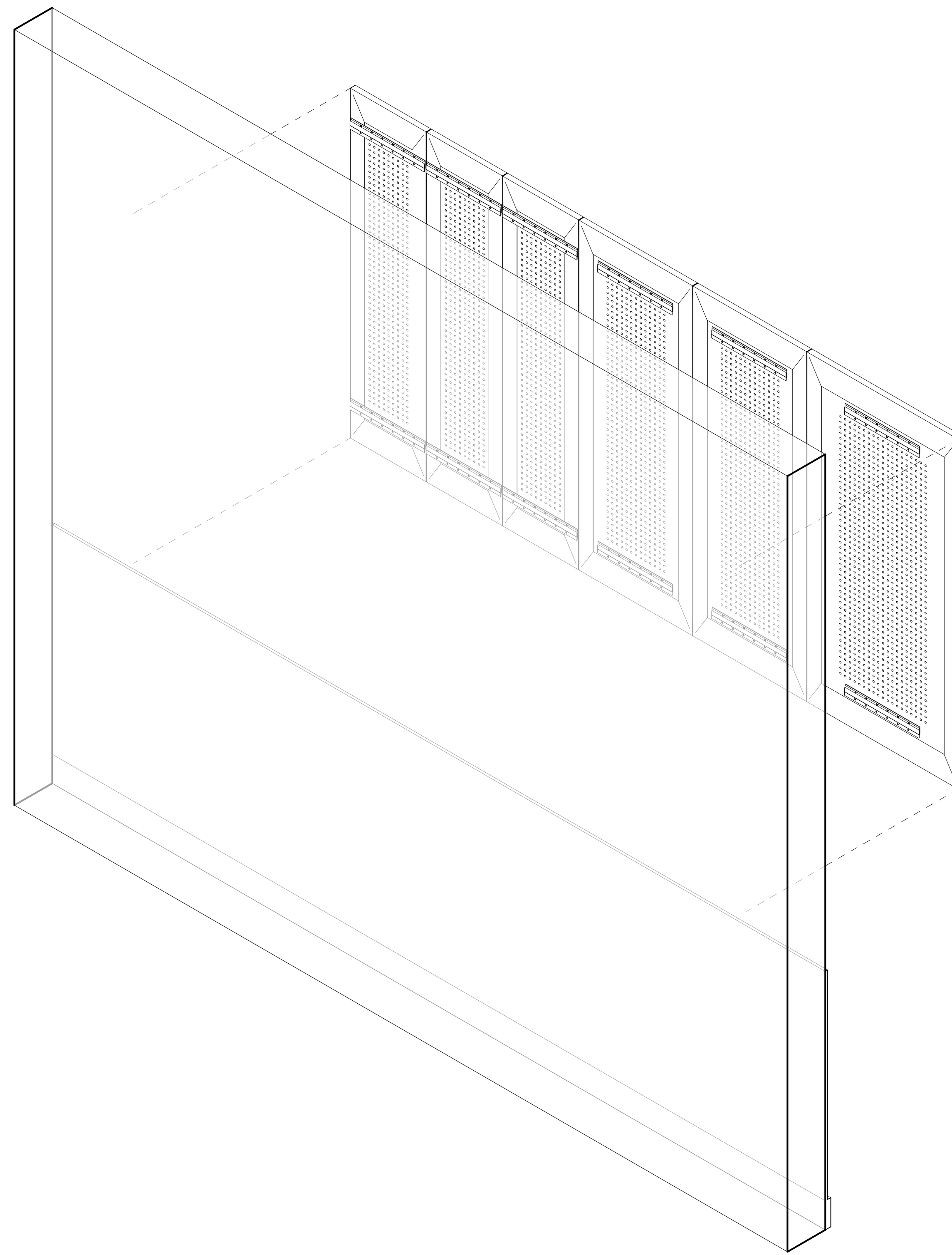

3 TOCKKY FWP - FELT WRAPPED PANELS
ASSEMBLY 8'x4' - INSTALLATION

NO.		REVISIONS:	NAME:	DATE:
1	SUBMISSION FOR APPROVAL			
2				
3				
4				



Tockky

**Product 6 - Tockky FWP
Felt Wrapped Panels**

DATE:
DRAWN BY:
DRAWING TITLE: TOCKKY FWP - FELT WRAPPED PANELS ASSEMBLY 8'x4' - AXONOMETRIC VIEW 1
PROJECT NUMBER:
DRAWING NUMBER: 3.3

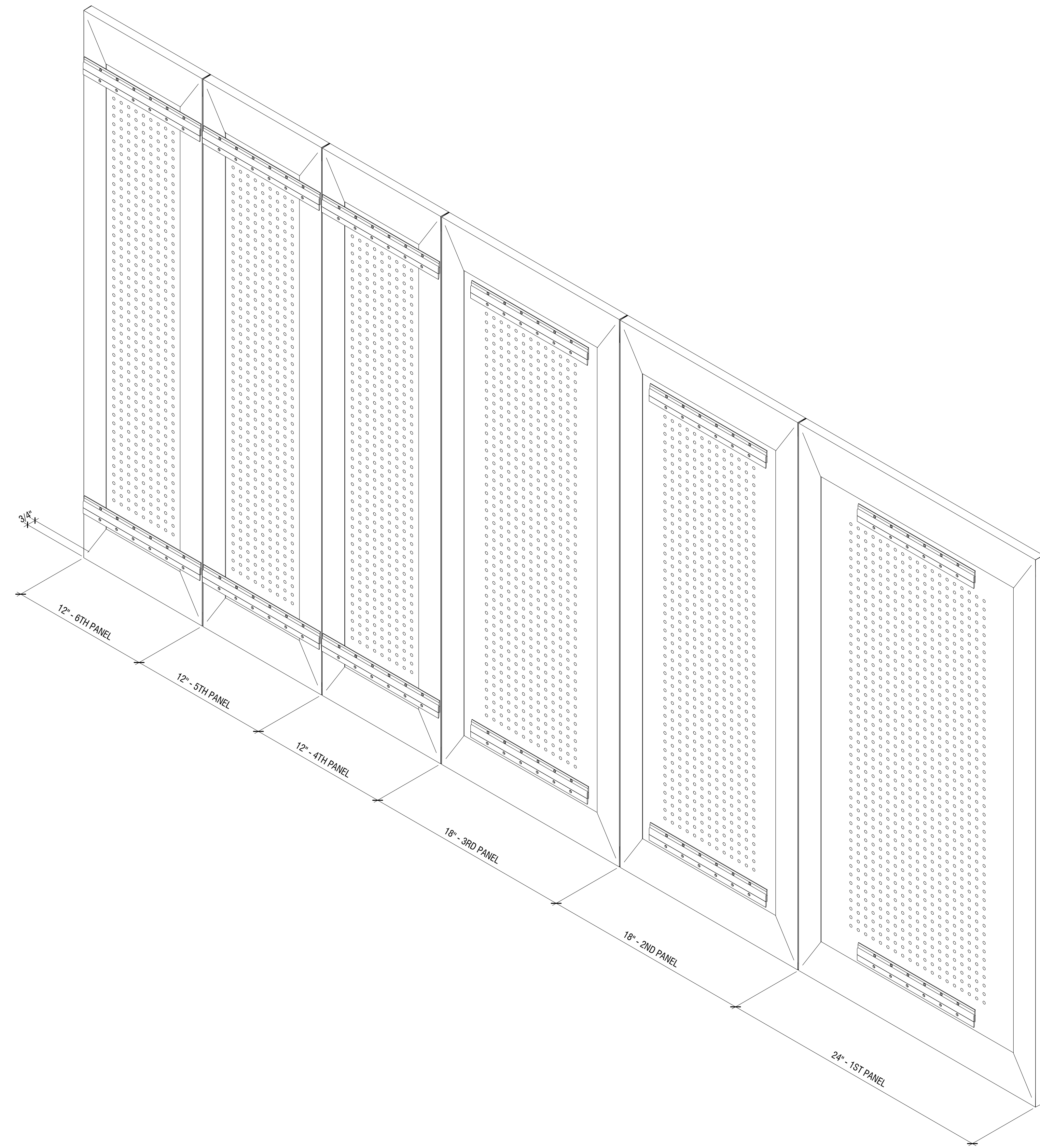

1 TOCKKY FWP - FELT WRAPPED PANELS
ASSEMBLY 8'x4' - 3D AXON

NO:	REVISIONS:	NAME:	DATE:
1	SUBMISSION FOR APPROVAL		
2			
3			
4			



Product 6 - Tockky FWP
Felt Wrapped Panels

DATE:
DRAWN BY:
DRAWING TITLE: TOCKKY FWP - FELT WRAPPED PANELS ASSEMBLY 8'x4' - AXONOMETRIC VIEW 2
PROJECT NUMBER:
DRAWING NUMBER: